

**Mastercam X<sup>6</sup>**

**Router**



**SIMTEK**

THE BEST OF CAD / CAM / CAE WORLD

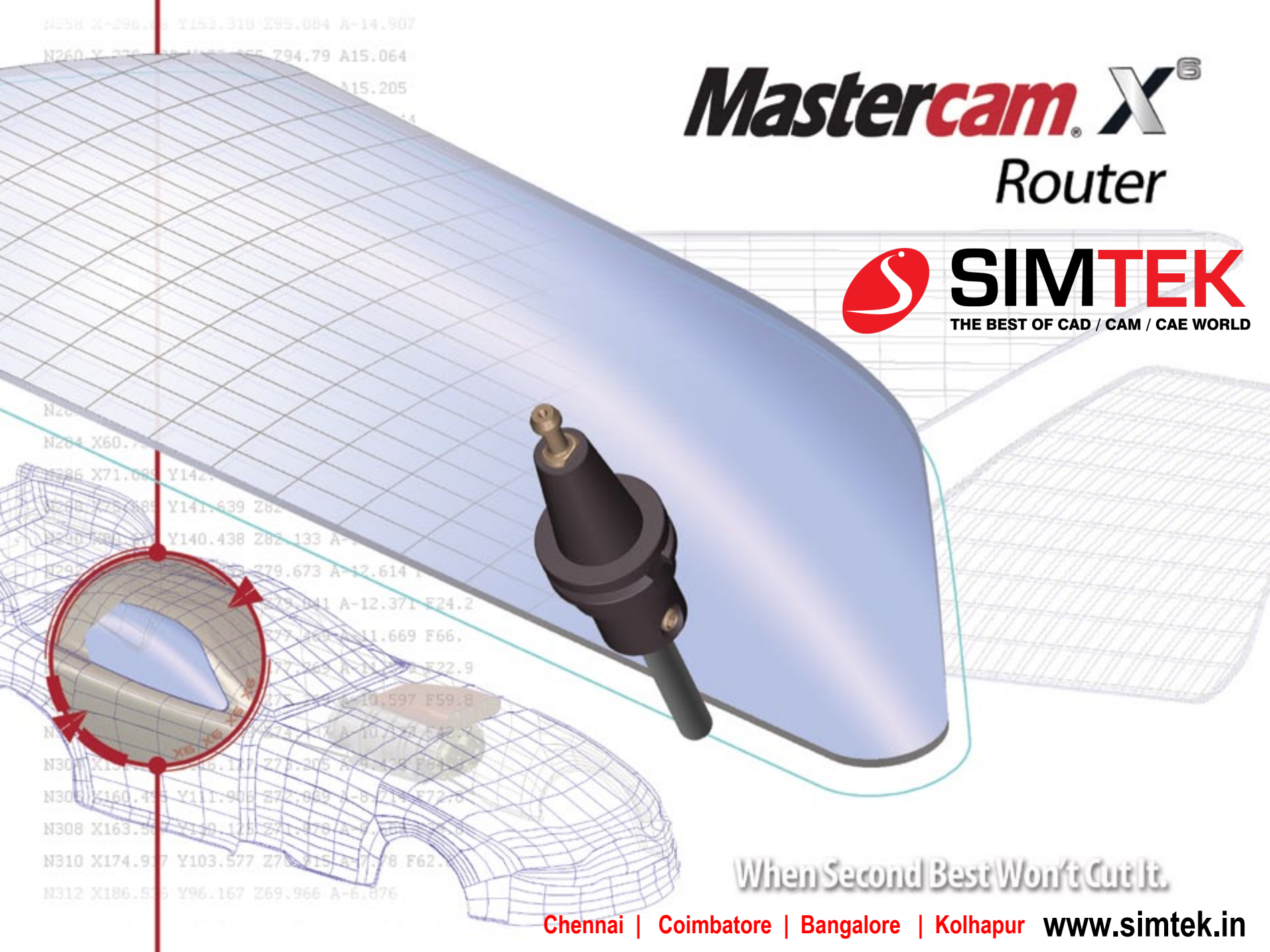

**When Second Best Won't Cut It.**

Chennai | Coimbatore | Bangalore | Kolhapur [www.simtek.in](http://www.simtek.in)

*CNC Software, Inc. is committed to bringing environmentally friendly and socially responsible practices to our industry.*

*The brochure you are reading has been condensed to decrease paper consumption. These are some of Mastercam's most important highlights, but there's much more information online.*

## *A Few Simple Clicks*

# **Powerful Part Modeling**

Mastercam's streamlined CAD engine makes design work easier than ever before. Each piece of geometry you create is "live," letting you quickly make modifications until it's exactly what you want. Some of Mastercam's modeling tools include:

- **Easy 2D and 3D geometry creation** with wireframe, surface, and optional solid modeling.
- Mastercam's specialty modeling tools help you quickly create classic door designs (including reading information from an outside Excel file), staircase stringers, and more.
- Clearance fillets for easy mortise and tenon creation.
- Associative dimensions update as you change your model.
- Extensive CAD editing tools and unlimited Undo/Redo.
- User-definable drafting grid simplifies detailed construction.
- Customizable AutoCursor™ snaps to commonly used construction points.
- Analyze single points, between points, angles, and more.
- Save a description with your part to keep track of revisions.
- Built-in data translators for IGES, Parasolid®, SAT (ACIS solids), AutoCAD® (DXF, DWG, and Inventor™ files), SolidWorks®, Solid Edge®, STEP, EPS, CADL, and STL. Direct translators for CATIA®, Pro/E, and more are also available.
- Mastercam's File Tracking and Change Recognition give you an easy way to identify CAD edits and updated cutter paths.

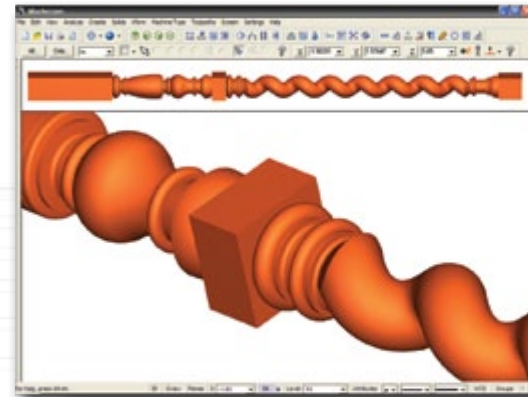

**Mastercam includes powerful wireframe and surface modeling tools, perfect for creating everything from simple to complex models.**

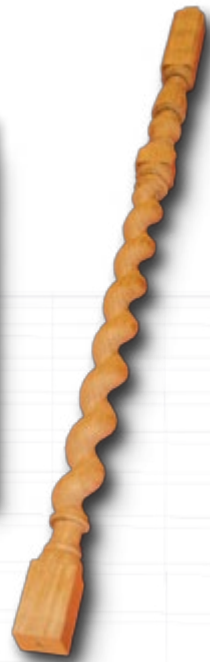

## **Automatic Toolpathing**

Mastercam includes Automatic Toolpathing (ATP) links to today's popular cabinet design software. ATP lets you choose machining strategies that will automatically be applied to the cabinet parts. When selected, Mastercam's ATP automatically scans each layer or level and programs them with the toolpath types of your choice. This is especially useful in large projects with many different components. With a modest amount of setup, you can save huge amounts of time by letting the software automatically find, chain, and toolpath all the elements of a job.

# Intelligent Machining

As the world's most widely-used CAM software\*, Mastercam is dedicated to making your entire process easier from start to finish. Here are just a few of the things Mastercam offers to help you make the most of your time.

## Capture Your Machining Knowledge

Mastercam's full associativity gives you the power to capture your work and build on your experience. Once you program a part—no matter how complex—you can modify any element of the job and immediately get updated toolpaths without starting over. You can also build a library of your favorite machining strategies. Choose any of your saved operations, apply them to a part, and Mastercam helps adapt them to the new model. It's fast, easy, and productive—the way programming should be.

## Machining Stock Model

A precise machining stock model delivers a variety of benefits—viewing and verifying work as it progresses, performing stock model comparisons, and easily choosing existing stock for rest machining. Mastercam gives you the power to create accurate, fully-associative stock models at any point in your machining process. You can reference the model within that project or save it as geometry for other uses.

## Dependable Toolpath Verification and Machine Simulation

Knowing your results before committing tool to material is crucial. Mastercam gives you several ways to ensure that your part will come off the machine exactly as you intended, including full Machine Simulation, solid-model verification with tool and holder checking, and toolpath backplotting. These functions deliver vital information about every aspect of the tool motion so you know for sure that what you see is what you get.

\* Source: CIMdata, Inc.

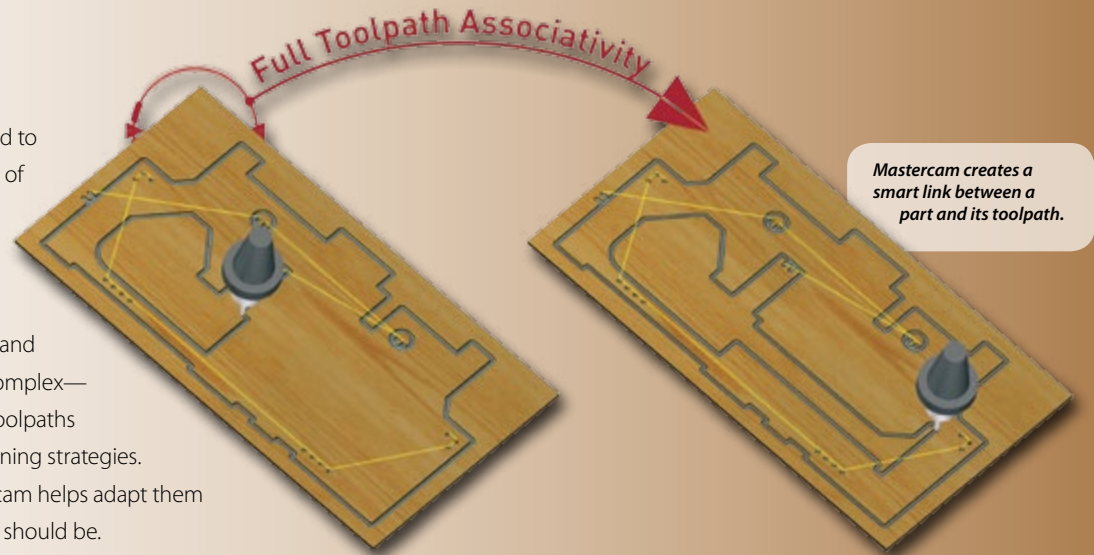

Full machine simulation delivers a practical view of how your toolpaths interact with your equipment.

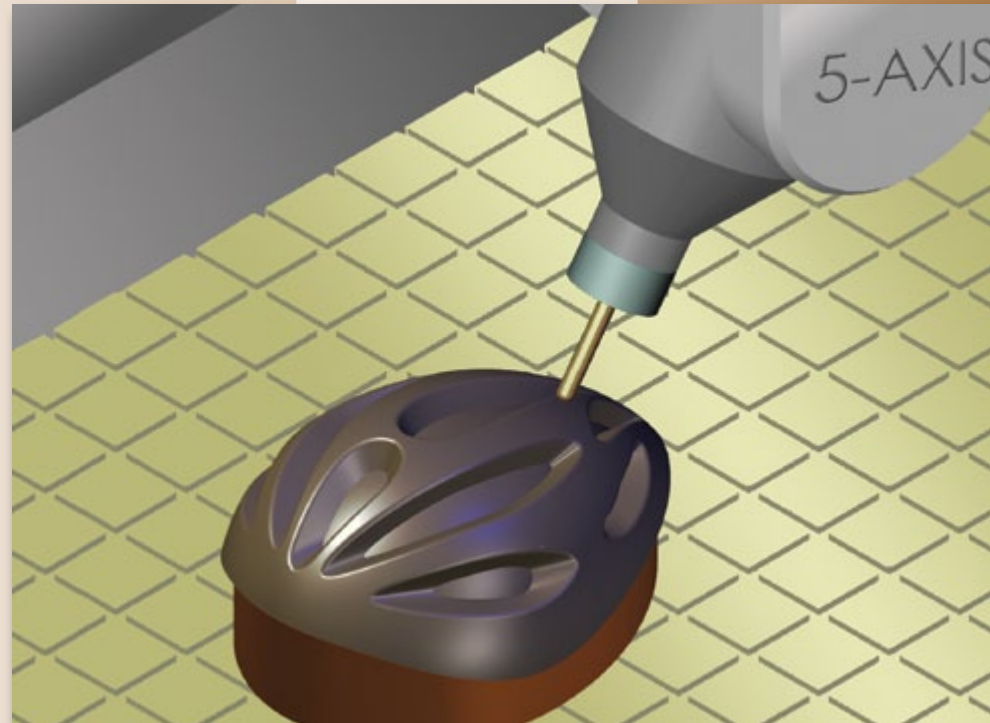

## 2D Toolpaths **Contouring, Drilling, and Pocketing**

2D machining ranges from the very simple to the very complex. Mastercam delivers all the tools you need for these operations. Highlights include:

- **Dynamic Cutting** creates an active toolpath that delivers more consistent cutting conditions and allows use of the entire tool flute length, while reducing machining time.
- **Feature Based Machining (FBM)** automatically programs a solid model's pockets, contours, and drilling routines, including block drill support.
- **2D High Speed Toolpaths (HST)** create smooth motion, extending tool life and reducing or eliminating hand finishing
- Standard pocketing styles include zigzag, one way, true spiral, constant overlap spiral, "morph" pocketing, and open pocketing, each with optional finish passes.
- Contour and pocket remachining use smaller tools to automatically clean out material left from previous operations.
- **Region Chaining** delivers a fast and easy way to adjust your 2D high speed machining areas.
- Ability to click and drag a machining start point to anywhere on your model.
- Fast, efficient **block drilling**.
- Mastercam's engraving feature delivers the effect of classic hand-carved art using your CNC machine.
- Visit [www.MastercamRouter.com](http://www.MastercamRouter.com) for a complete list.



*"Mastercam Router is excellent for both volume production and one-off custom work. Overall, Mastercam is an excellent program for a custom millwork shop like ours."*

Livio Passalent, President  
Crescent Cabinet Company Ltd.  
Hamilton, Ontario, Canada

Aggregate tooling support.

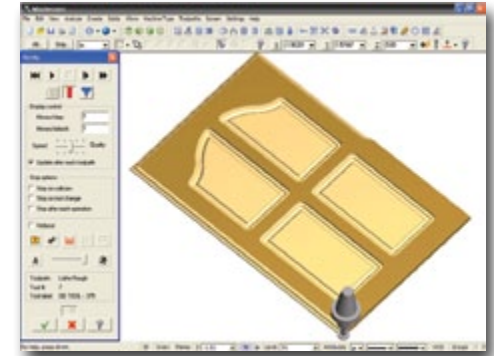
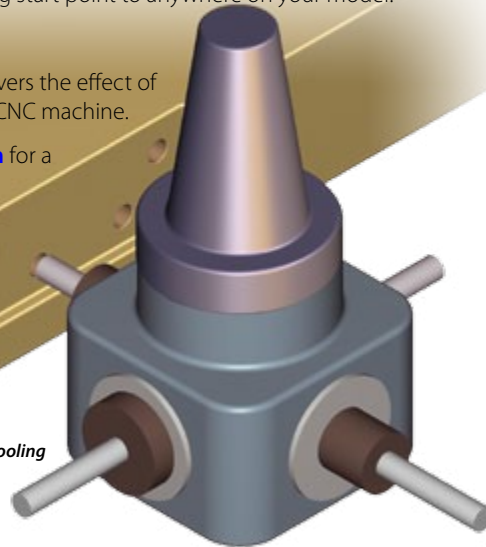

Fast, easy contouring and pocketing.

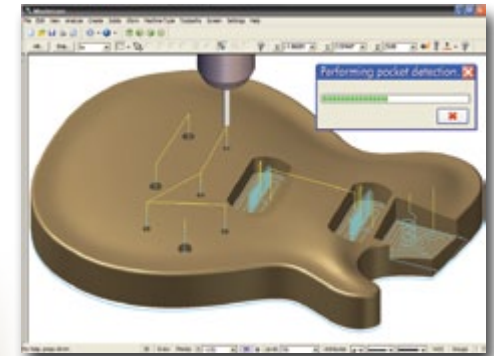

Mastercam's Feature Based Machining (FBM) automates the programming of 2D solid features.

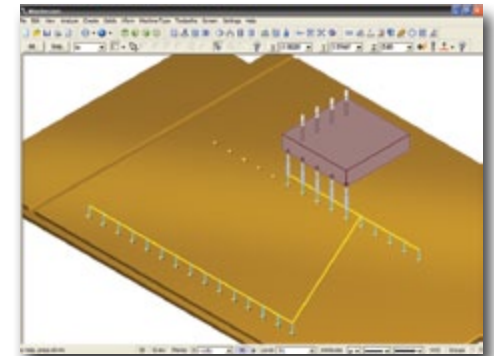

Fully optimized drilling, including block drilling.

# Part and Toolpath Nesting

High yields can be crucial to a job's profitability. Mastercam includes essential nesting capabilities for parts and toolpaths:

- Fast, efficient **interlocking part nesting** maximizes material use.
- **Complete control** over part-to-part distance, sheet margins, and more.
- Easily "drag" parts around on your sheet, or from sheet to sheet.
- Directly place CAD models from a variety of sources.
- Group sets of parts and assign part nesting priorities.
- Double-sided and common-edge nesting.
- Custom sheet definition and "filler" parts reduce waste.
- Automatic vertical/horizontal cut-offs preserve rectangular leftovers.
- Save sheet scrap for later use.
- Create custom labels and reports.

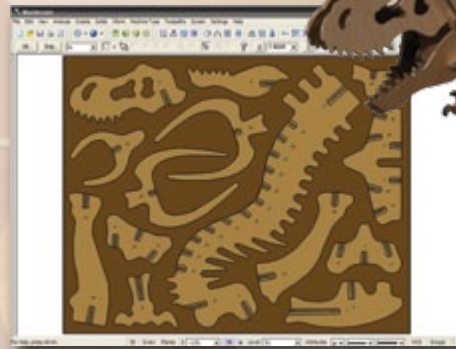

*Mastercam gives you complete control over part-to-part distance.*

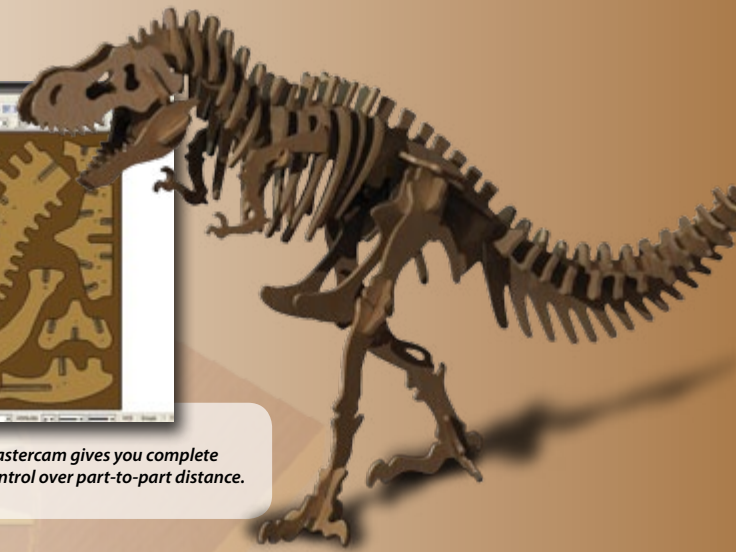

*Program a part once, and then nest that process so that each part is cut with identical motion.*

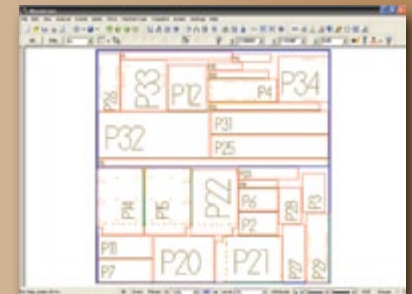

*Easily add identification to your nested parts.*

# Tabs, Onion Skinning, and Breakthrough Control

Efficient flat panel cutting relies on easy control over tabs, webs, and cutting specifics.

- Leave an **"onion skin"** that maintains vacuum and keeps parts from moving.
- Complete **tab control** including full tabs and partial tabs.
- All tabs are fully editable and moveable, and have adjustable ramp angles.
- Manually place the tabs or allow Mastercam to do it automatically.
- Tab cutoff passes can be run after each part, or after all parts are done.
- Breakthrough control lets you easily define how deep past the part your tool will go.



*Easy-to-use selections for a wide variety of tabs.*

## 3D Toolpaths

# Roughing, Finishing, and Cleanup Machining

Operations that quickly deliver a clean and precise finished part are essential to efficient NC programming. Here are just a few of Mastercam's popular 3D machining techniques:

- Cut multiple surfaces, solid models, or a combination of both.
- **Constant-Z rough "remachining"** identifies and machines areas and critical depths that need to be roughed with a smaller tool.
- High Speed OptiRest uses Mastercam's new stock model to identify and efficiently machine areas that need to be roughed with a smaller tool.
- 3D Toolpath Refinement allows unsurpassed control on surface cuts, delivering superior finishes and optimized cycle times.
- 3D "projected" machining creates a consistent, smooth finish while following the natural curves of the geometry.
- **Constant scallop machining** maintains a consistent finish on sloped and flat surfaces alike by using a consistent 3D stepover.
- Flowline machining cuts single or multiple surfaces using their natural shape to define the cutter path and deliver a smoother finish.
- Full check surface support.
- **Smart hybrid finishing** and **hybrid leftover machining** create single toolpaths that change cut methods as the slope of the model changes.
- **Pencil tracing** walks a tool along the intersection of surfaces to clean out hard-to-reach areas. Perform single or multiple passes for precision cleanup.



*"We use Mastercam's High Speed Machining to hit the sweet spot where machining is accurate, fast, and least abusive of the machine. We recently shaved 26 hours off three runs of a part, turning it from a low-profit to a high-profit job."*

John Graney  
Surface Solutions Inc.  
Ipswich, MA

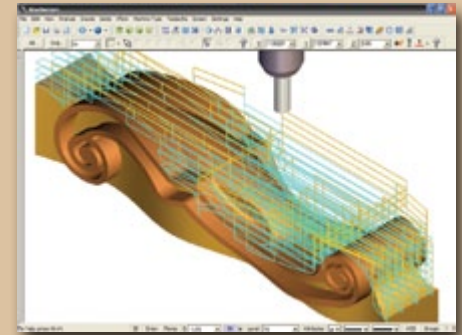

*Mastercam offers a variety of fast, efficient roughing techniques for bulk material removal.*

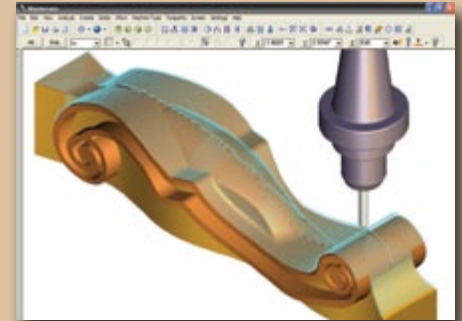

*Constant scallop finishing delivers a smooth, consistent finish.*

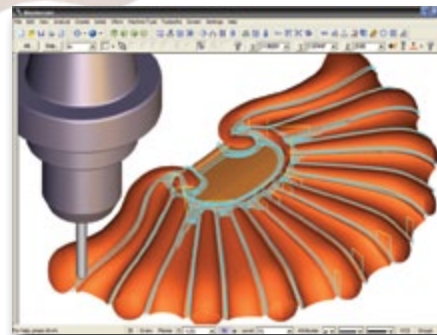

*Automated leftover machining delivers a clean finish.*

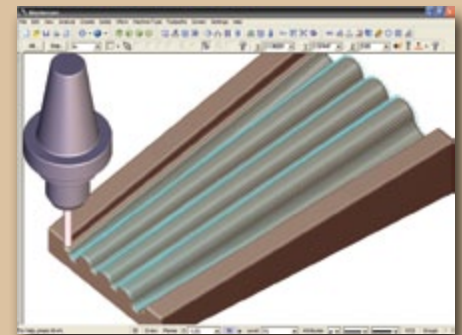

*Smooth flowline finishing follows the natural shape of the surface to define the cutter path.*

# A Wide Range of Strategies

## ***Multiaxis Machining***

Multiaxis machining can dramatically increase a shop's competitiveness. Mastercam offers a wide range of multiaxis machining strategies. With Mastercam, you have complete control over tool motion. Some highlights of Mastercam's multiaxis machining:

- **Multisurface 5-axis roughing and finishing** including depth cuts, plunge roughing, and flowline machining and drilling.
- Swarf fanning and swarf machining over multisurface floors, plus "rail" swarf cutting for added control.
- Machine 5-axis curves with independent definitions of tool side angle and lead/lag angle.
- Create 5-axis contour toolpaths around surface edges for applications such as trimming vacuum-formed parts.
- 5-axis circle milling.

- Easy 5-axis drilling and routing.
- Create full 5-axis motion from a 3-axis toolpath.
- **Advanced gouge checking** and a 5-axis "safe zone" around the part.
- Minimum tilt control helps prevent tool motion that would cause tool holder collisions.
- Complete control over the tool axis, lead/lag, entry/exit, and tilt. These simplify even the most difficult multiaxis jobs.
- See a complete list of 3D and multiaxis tools at [www.MastercamRouter.com](http://www.MastercamRouter.com).

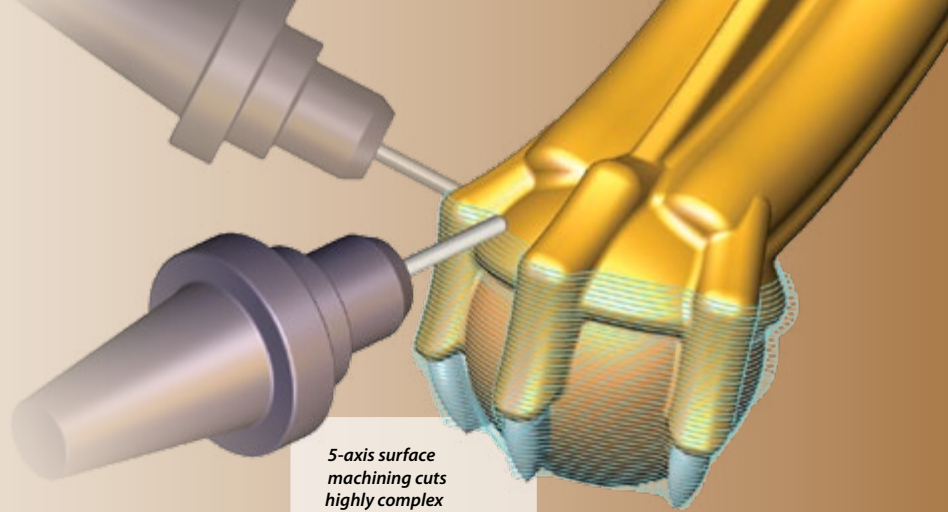

*5-axis surface machining cuts highly complex shapes with a smooth, consistent motion.*

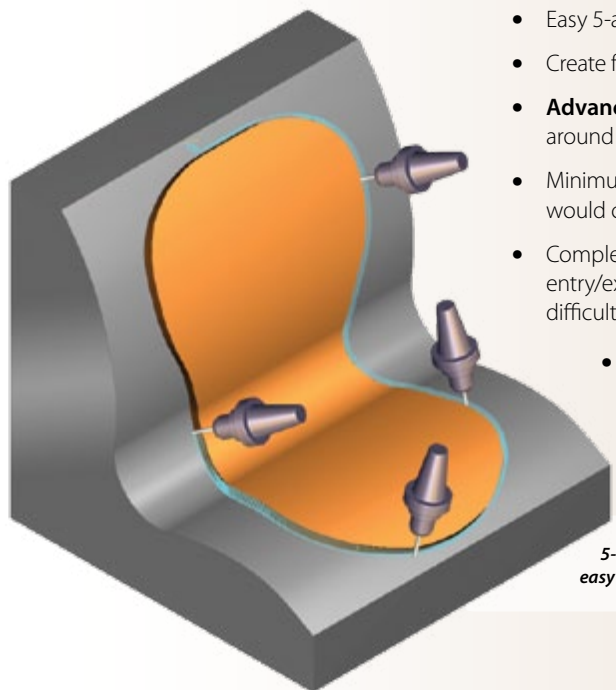

*5-axis cutting for easy part trimming.*

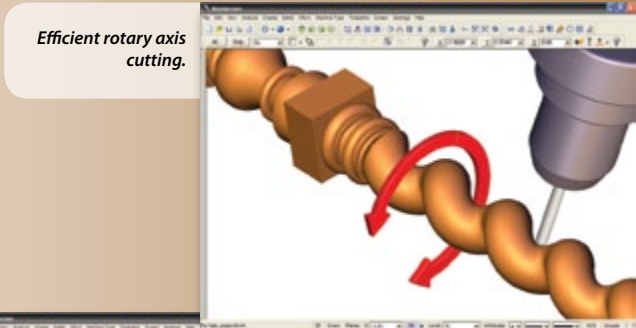

*Efficient rotary axis cutting.*

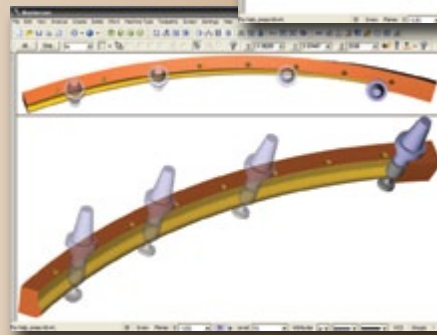

*Multisurface swarf cutting keeps the tool edge against the surface for a smooth finish.*

## Specialized Options

Very often, that little something extra—that one additional CAD or CAM tool—makes a specific job easier, faster, and more profitable. Mastercam offers a set of specialized add-in options for these occasions including:

- Use of point data to create surfaces or STL data for reverse engineering and manufacturing.
- Sophisticated tools for traditional blueprint and CAD-based inspection.
- Focused 5-axis programming tools tailored to cutting multi-bladed parts.
- Complete programming for complex machining robots.
- See a full list at [www.mastercam.com/Products/Addins](http://www.mastercam.com/Products/Addins).

## System Requirements

- **Processor:** 2.5 GHz (minimum) 32-bit or 64-bit Intel®-compatible processor; Mastercam will automatically identify the processor and install either the 32-bit or 64-bit version.
- **Operating System:** Windows® XP, Windows Vista® (Business or Ultimate), or Windows 7 (Ultimate or Professional) including the latest service packs and recommended updates.
- **Memory:** 2 GB (minimum), 3 GB available hard disk space (minimum).
- **Graphics:** 256 MB OpenGL-compatible graphics card, 1280x1024 pixel screen resolution (minimum).
- **Mouse:** Windows-compatible 2-button or 3-button mouse (or with middle mouse wheel).

**Mastercam**  
cnc software, inc.

671 Old Post Road Tolland, CT 06084 USA  
(800) 228-2877 • (860) 875-5006 • Fax (860) 872-1565  
[www.mastercam.com](http://www.mastercam.com) • [mcinfo@mastercam.com](mailto:mcinfo@mastercam.com)



	Mastercam Router	Router Entry	Router	Router Plus	Router Pro
<b>CAD</b>					
Create and dimension live wireframe geometry		x	x	x	x
TrueShape Nesting		Optional	x	x	x
Read/write IGES, DXF, SAT, Parasolid, EPS & more			x	x	x
Read native AutoCAD, SolidWorks, Solid Edge & more			x	x	x
Read native CATIA and Pro/E files			Optional	Optional	Optional
Live Surface modeling			x	x	x
CAD File Change Recognition		x	x	x	x
Solid modeling			Optional	Optional	Optional
<b>CAM</b>					
In-process stock model		x	x	x	x
Feature Based Machining			x	x	x
Dynamic Milling			x	x	x
Fully associative toolpaths		x	x	x	x
Drilling		x	x	x	x
2D contour cutting		x	x	x	x
Basic pocketing		x	x	x	x
3D contour cutting, trimming, and remachining			x	x	x
Advanced pocketing, including open pockets			x	x	x
Block drilling			x	x	x
Tabs			x	x	x
Right-angle head support			x	x	x
Engraving			x	x	x
On-screen toolpath verification			x	x	x
Single & limited multisurface roughing				x	x
Single & limited multisurface finishing				x	x
Full multisurface & solid roughing					x
Full multisurface & solid finishing					x
Full multisurface & solid cleanup machining					x
Full multisurface & solid highspeed machining					x
Full multisurface & solid OptiRough cutting					x
Full multisurface & solid hybrid finishing					x
5-axis drilling & curve machining			Optional	Optional	Optional
Full 4- & 5-axis machining					Optional

Mastercam® and Mastercam University™ are registered trademarks of CNC Software, Inc. ©Copyright 1983-2011. All rights reserved.  
SolidWorks is a registered trademark of DS SolidWorks Corporation. ISCAR is a registered trademark of ISCAR, Ltd.  
All other trademarks are property of their respective owners.